



MOMO 2117 Monitor Arm Motion (white)

Key Benefits

- Height Adjustable
- Suitable for one, two or a whole series of monitors
- Easy to install
- Flexible modular system
- TÜV certified / 10-year guarantee

The ergonomic monitor arm for every workplace The MOMO 2117 is a monitor arm specially designed for height-adjustable monitors. The monitor arm can hold displays up to 43 inches and weighing up to 20 kg.

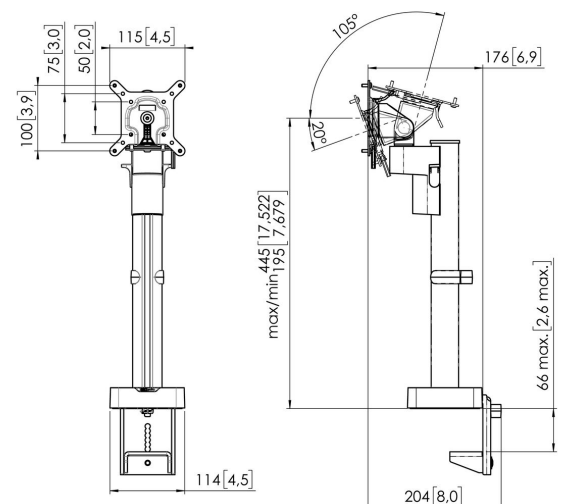



MOMO 2117 Monitor Arm Motion (white)



Specifications

Min. screen size (inch)	10
Max. screen size (inch)	43
Max. screen size (inch)	43
Universal or fixed hole pattern	Fixed
Max. height of interface (mm)	115
Max. width of interface (mm)	115
Max. weight load (kg)	20
Max. weight load (Lbs)	44.09
Max. center display	445
Max. thickness desk	66
Turn	Up to 180°
Number of pivot points	1
Rotate	Up to 180°
Tilt	Tilt -20°/+105°
Height adjustment	Manual operated
Adjustable depth	No
Adjustable height	Yes
Mounting Possibilities	On and through desk
Article number (SKU)	7121171
EAN single box	8712285353765
Colour	White
TÜV certified	Yes
Guarantee	10 years

VOGEL'S HOLDING BV (©)

All rights reserved.
Subject to printing errors,
technical and price
amendments.

Date: 2024-03-25



Vogel's. For Sure.